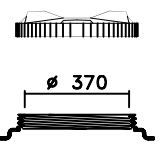
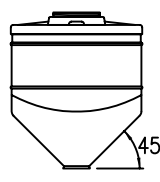
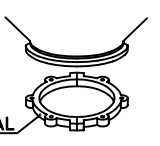
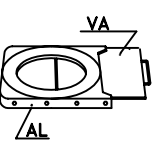
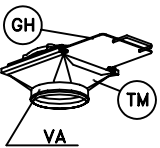
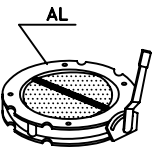
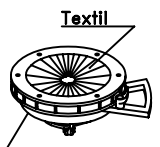
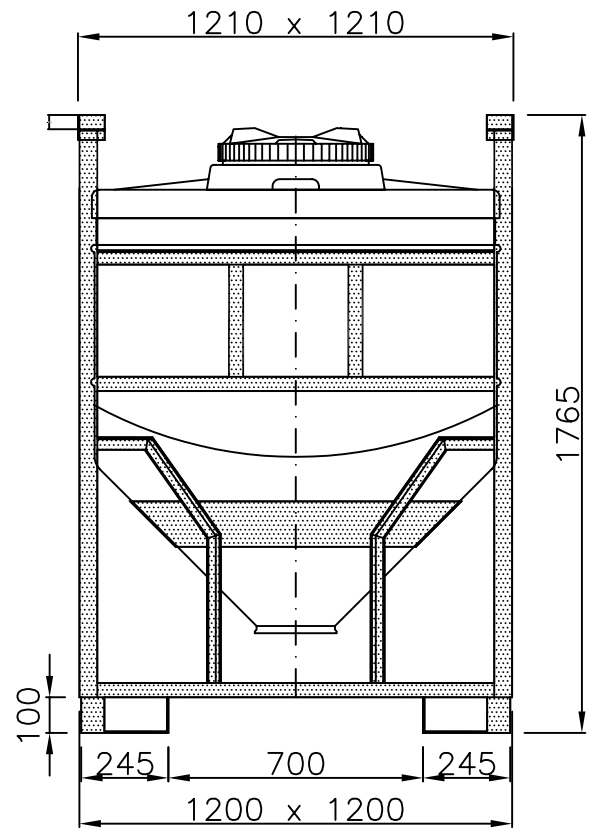
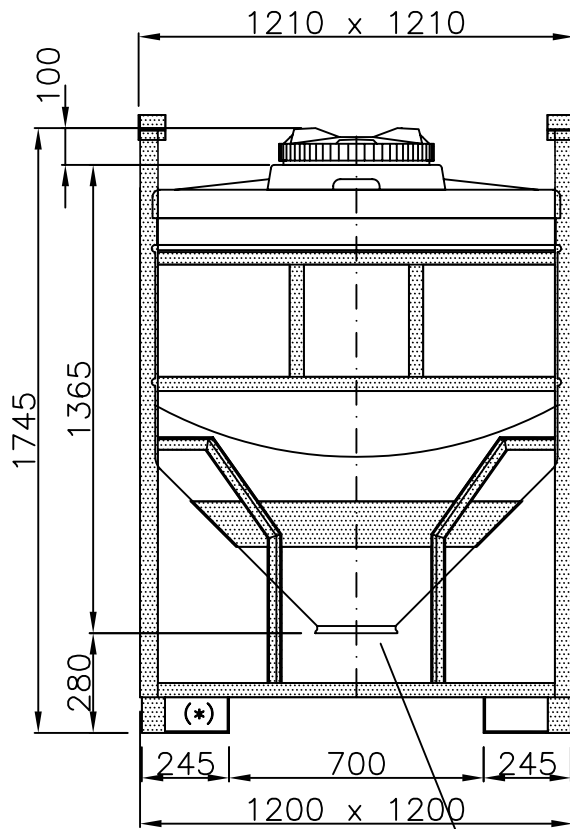

Container 1.000 Liter, Typ TB 11-2/P

CPF-410

Innenbehälter

CS 2

GH 2

TM 2

V2FS

DF 2



Entleerung Ø200

